



For The ON-THE-GO Pet™

INSTRUCTION MANUAL

DESIGNER 4-STEP

PG9840DBG/PG9840DCH/PG9840DSG/PG9840DTN
PG10140DBG/PG10140DCH/PG10140DSG/PG10140DTN



Carpet treads and designer cover remove easily and are machine washable.

To see our full line of products, visit us online at: www.petgearinc.com

CUSTOMER SERVICE HELP DESK

customerservice@petgearinc.com

Toll-Free 877-752-9123 - Eastern Standard Time 8am-3pm, Monday through Friday

PARTS LIST

Check that you have all the parts shown BEFORE assembling your product.
If any parts are missing, call Customer Service. No tools required.

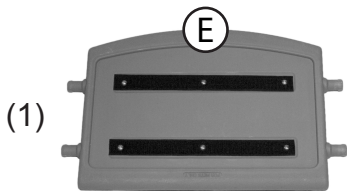
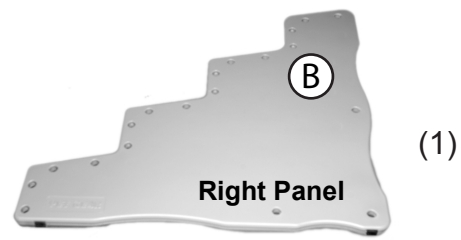
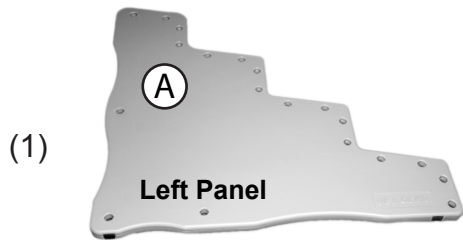

Top Stair

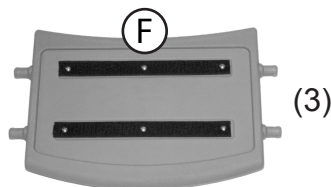

Stairs

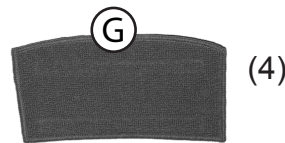

Carpet Treads



Designer Cover

INSTRUCTIONS

Step 1

With rubber grippers on the bottom, place right panel, part (B) on floor with PET GEAR Logo facing the floor and insert top stair, part (E).

Keep the **STRAIGHT EDGE** toward the back and rug facing the top.

Make sure there are no gaps between parts after inserting. (If inserting part is difficult put a little dish soap on doweled end before inserting.)

Step 2

Insert riser, part (C). Make sure there are no gaps between parts after inserting.

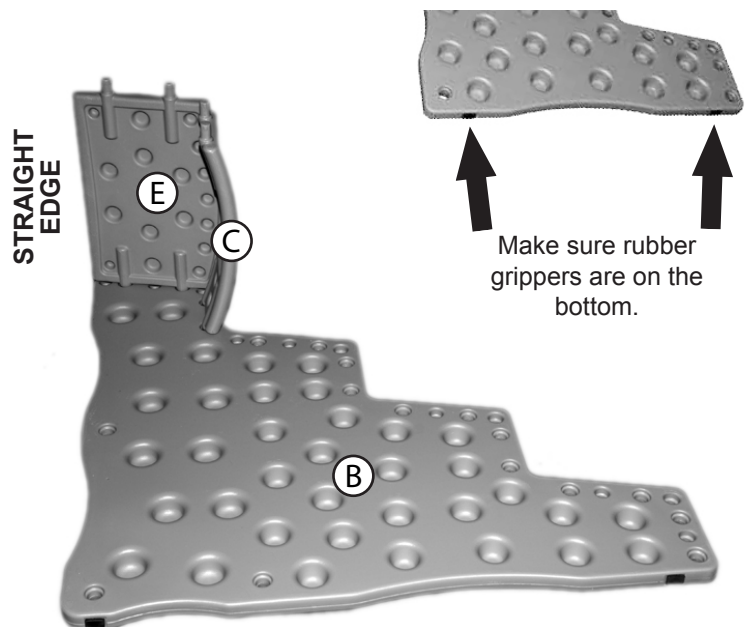

DESIGNER 4-STEP PG9840DBG/PG9840DCH/PG9840DSG/PG9840DTN
PG10140DBG/PG10140DCH/PG10140DSG/PG10140DTN

INSTRUCTIONS

Step 3

Insert stair, part (F). Note the **CURVED SIDE** direction. Make sure there are no gaps between parts after inserting.

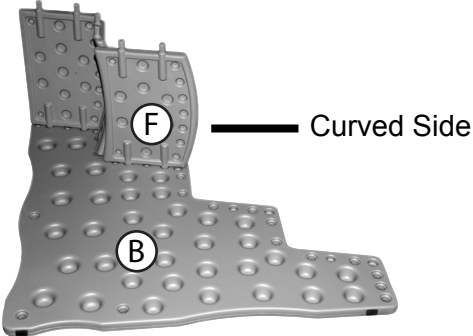

Step 4

Insert another riser, part (C). Make sure there are no gaps between parts after inserting.

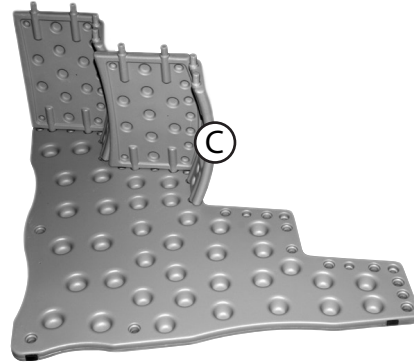

Step 5

Repeat Steps 3 and 4.

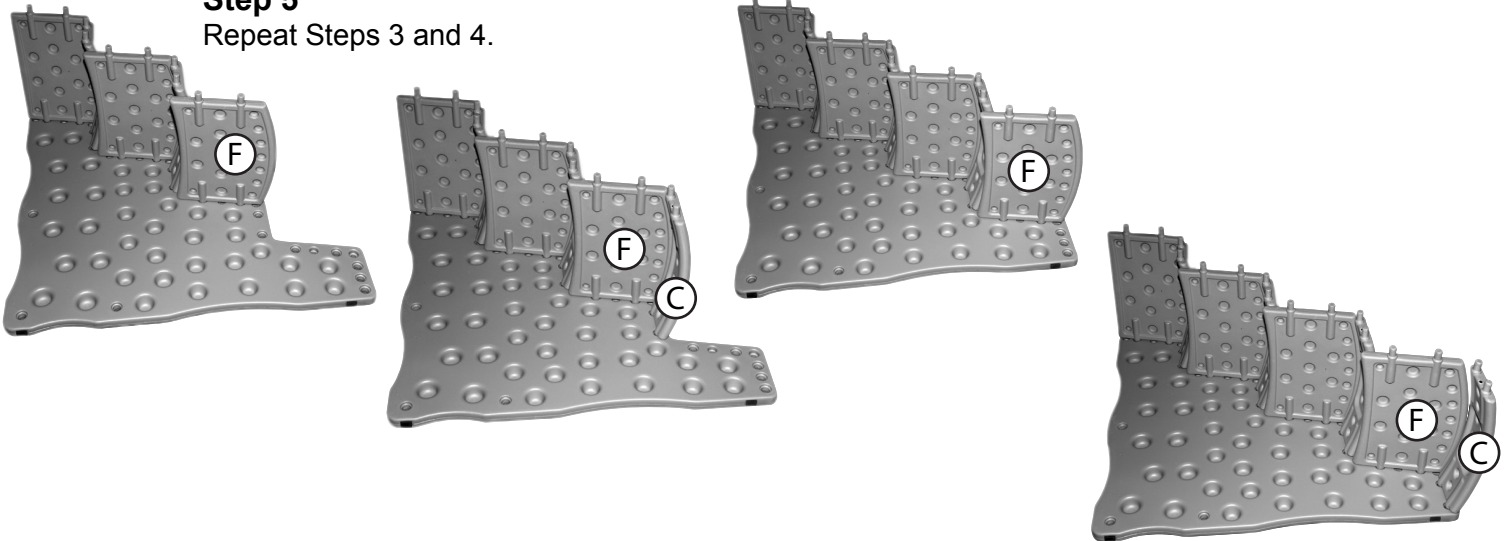

Step 6

Insert 3 dowels, part (D). Make sure there are no gaps between parts after inserting.

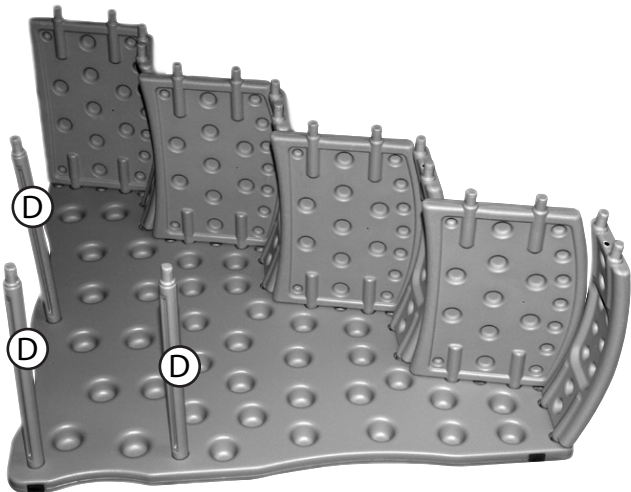

Step 7

Attach left panel, part (A). Align all holes before pushing panel down. Make sure there are no gaps between parts after inserting.

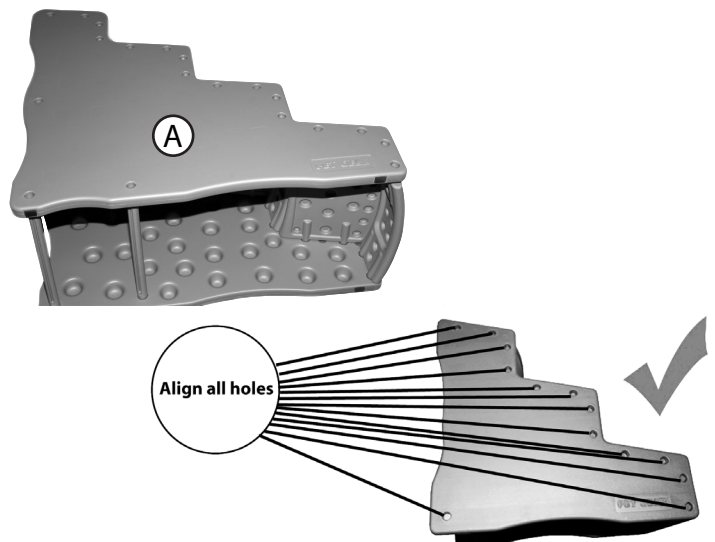

INSTRUCTIONS

Step 8

Unfold the Designer Cover, (H), and drape it over the steps. Pull the elastic strap over the bottom of the stairs.

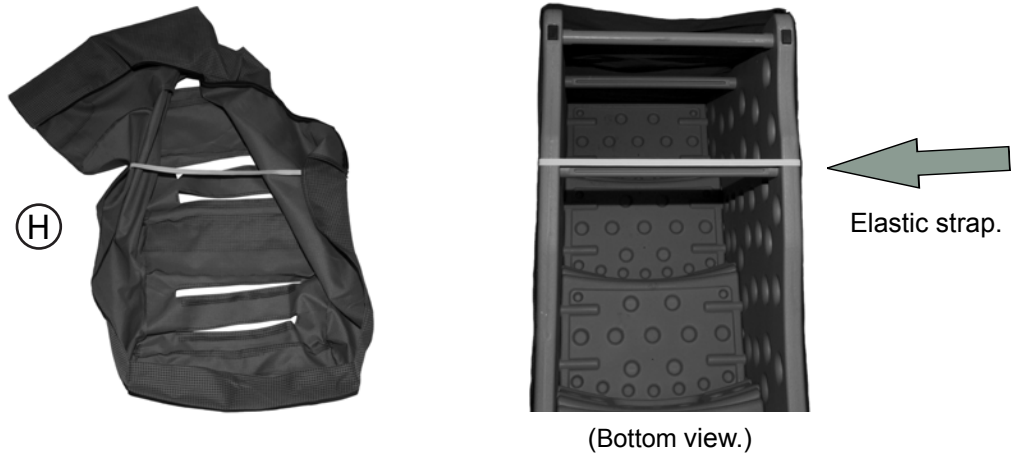

Step 9

Pull the zipper down toward the floor.

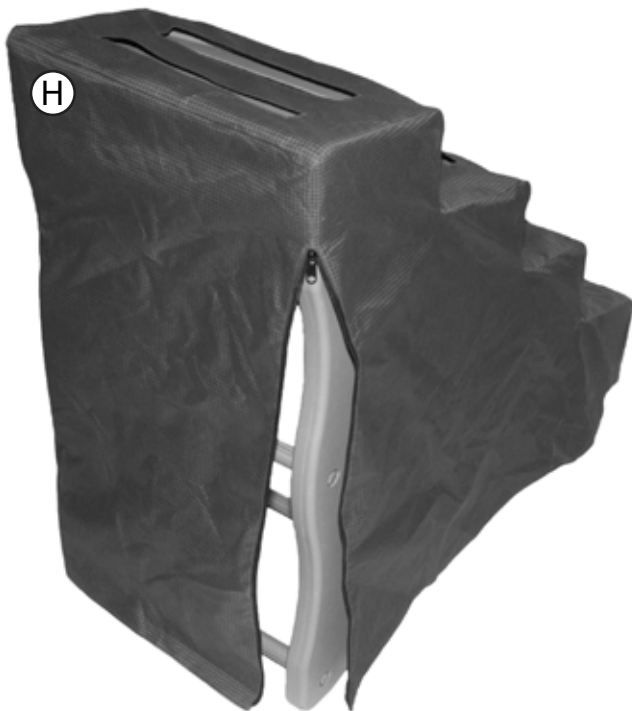

Step 10

Place carpet treads, (G), on top of the steps and connect with Velcro strips.

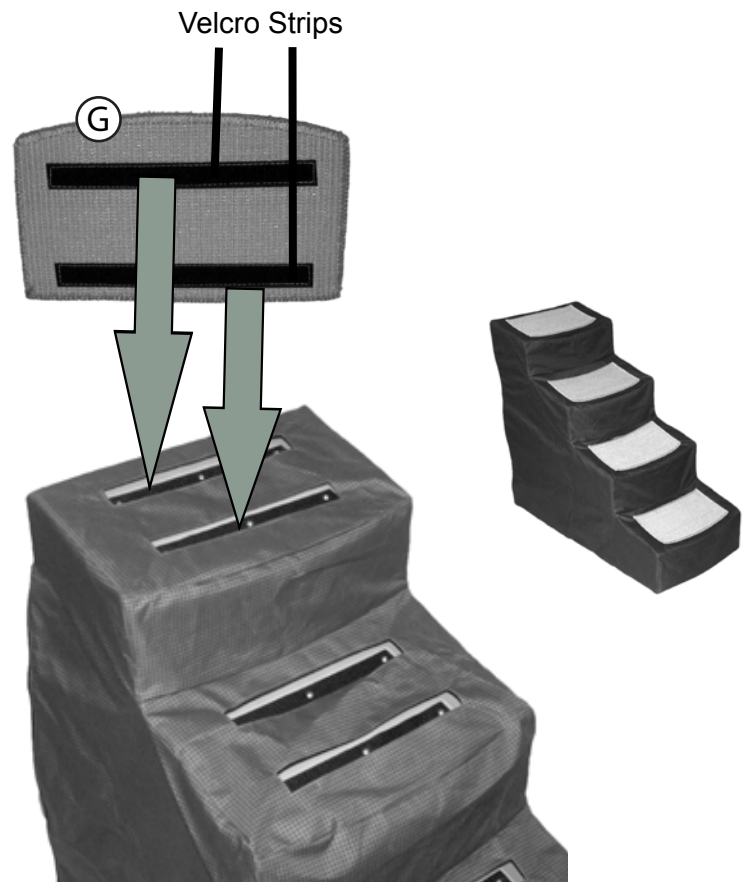

WARNING!

FOR PETS ONLY.

Not intended to be used as a restraining device for aggressive or dangerous animals that dig, chew or paw aggressively. Do not leave your pet unattended. **PET GEAR** is not liable for any damage caused by aggressive, destructive, immature or untrained animals. Do not use near an open or exposed flame. Failure to follow these warnings and the instructions could result in serious injury or death.

REPLACEMENT PARTS

Please have your model number ready before calling. Use only Pet Gear replacement parts.



**PO Box 99
West Rutland, VT 05777
877-752-9123
www.petgearinc.com**